

Honeywell Garrett® GT4718R

Compressor Inlet

HOSE CONNECTIONS
TABULATED AS (ϕ x L)

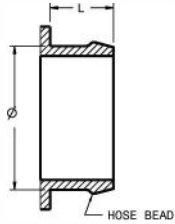

ϕ 152.4 x 32

Compressor Outlet

HOSE CONNECTIONS
TABULATED AS (ϕ x L)

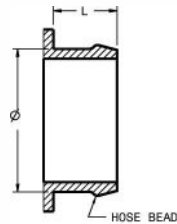

ϕ 88.9 x 32

Oil Inlet

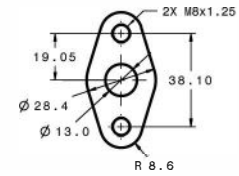

Turbine Inlet

"SMALL FRAME DIESEL"

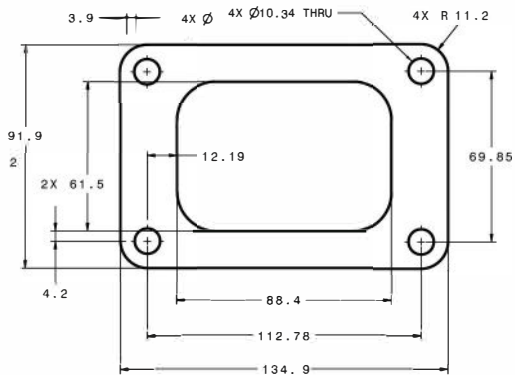

Turbine Outlet

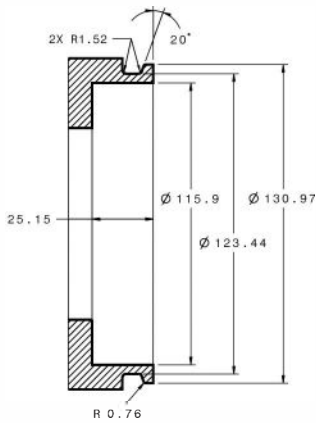

Oil Outlet

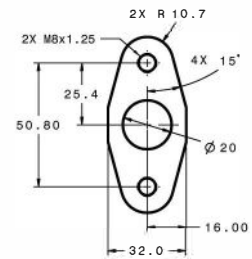

Water
Not Applicable

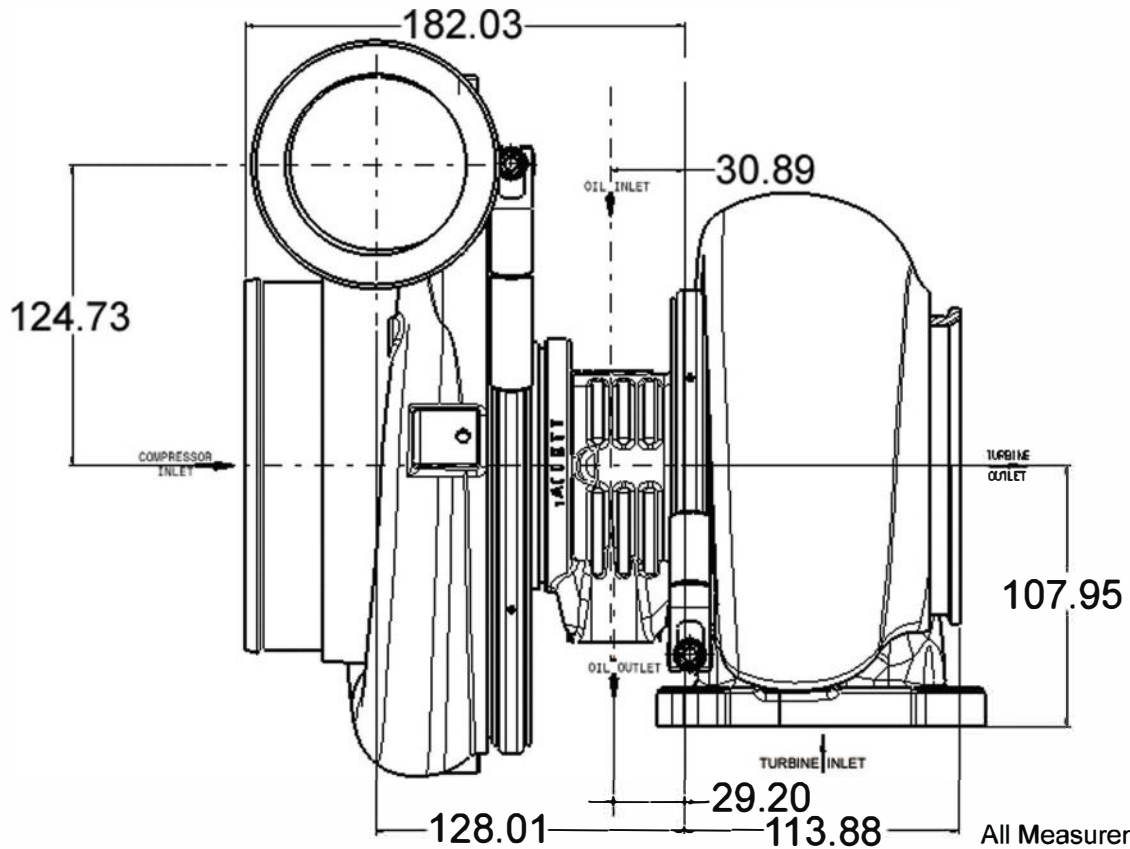

All Measurements in MM