

02 Compressor Inlet

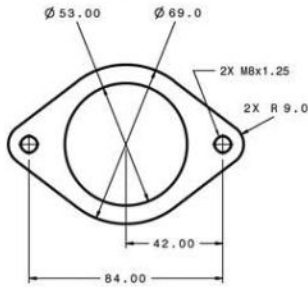

01 Compressor Outlet

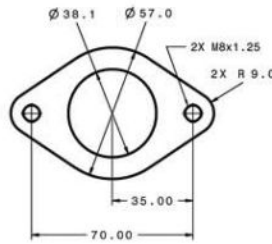

11 Oil Inlet

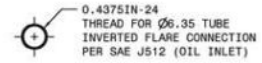

02 Turbine Inlet
"T25 WITH STUDS"

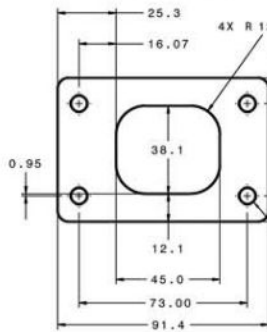

09 Turbine Outlet
"5 BOLT"

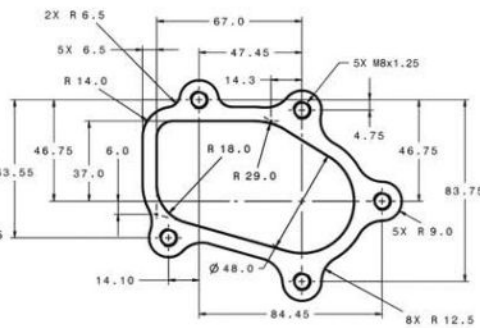

18 Oil Outlet

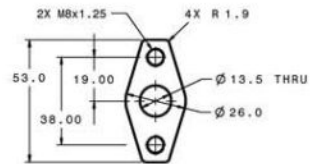

13 Water
M14 x 1.50

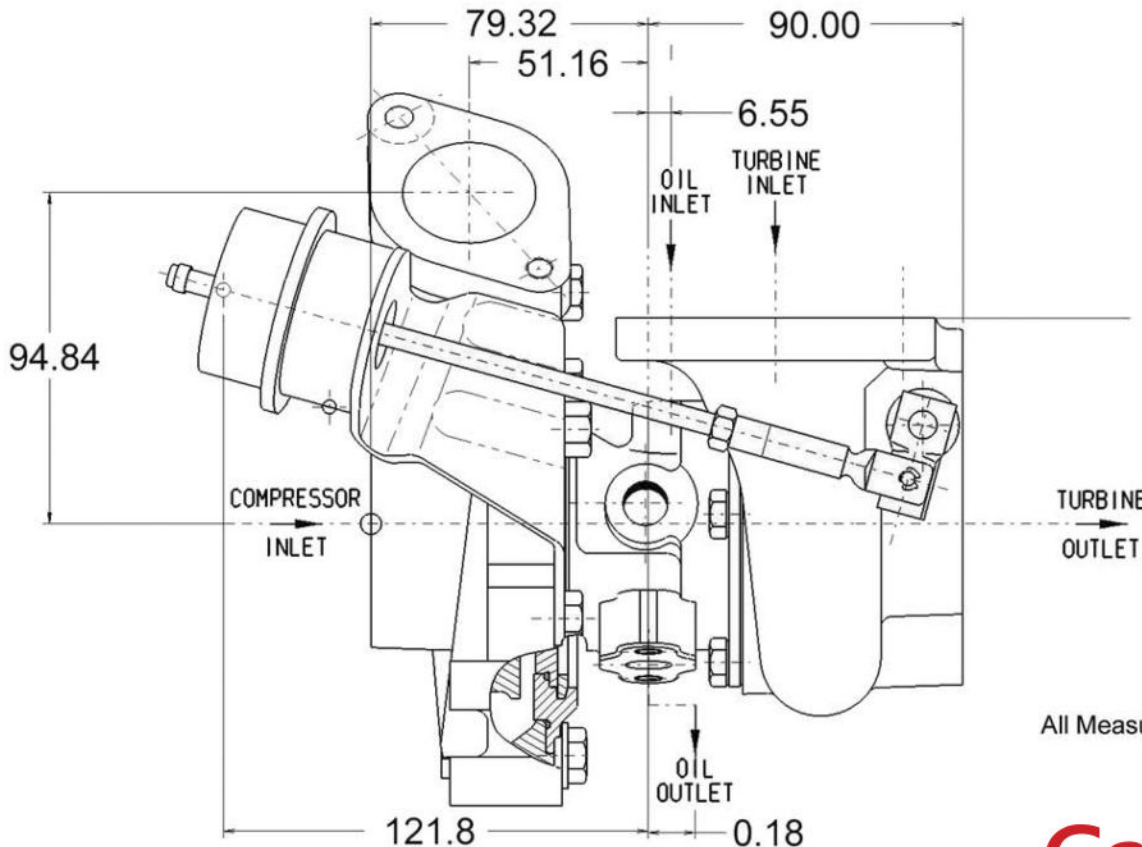

All Measurements in MM